

**POLYMER**

**PORCELAIN**

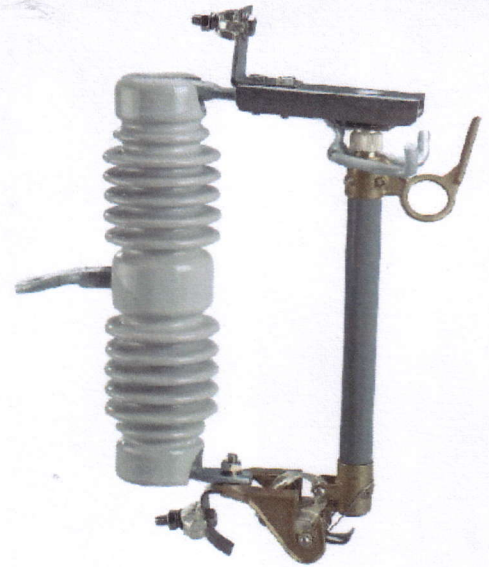
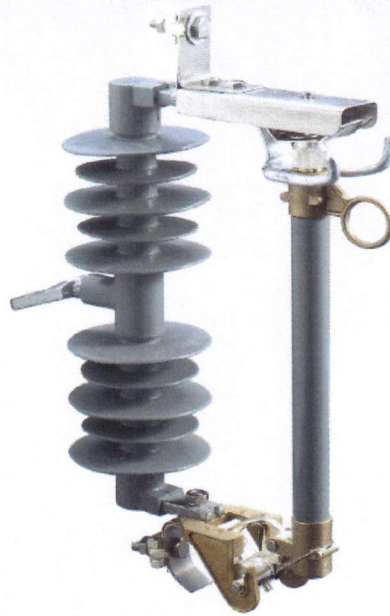
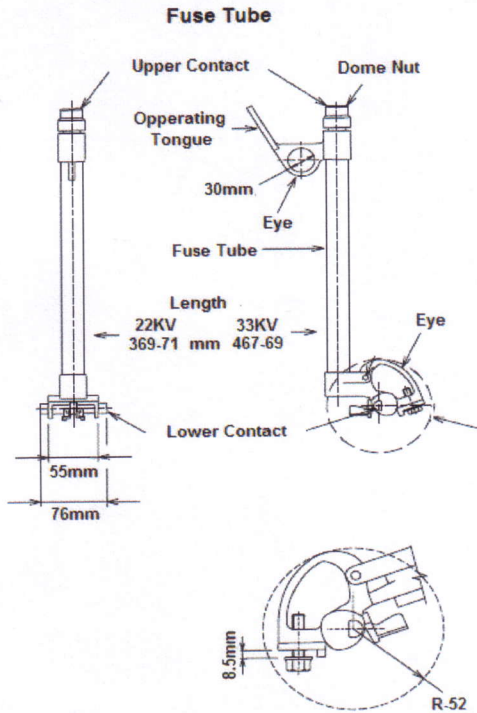

**SJC-5 PORCELAIN**

Type	Rated Voltage (KV)	Rated Current (A)	Breaking Current (A)	Impulse Voltage BIL (KV)	Power Frequency Withstand Voltage (KV)	Leakage Distance (mm)	Weight (Kg)	Dimensions (cm)
SJC-5	15-27	100	10,000	125	45	350	8.5	48X34.5 X10.5
		200	12,000	125	45	350	8.5	

**Top Contact Assembly**

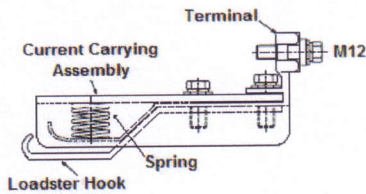

**SJC-13 PORCELAIN**

Type	Rated Voltage (KV)	Rated Current (A)	Breaking Current (A)	Impulse Voltage BIL (KV)	Power Frequency Withstand Voltage (KV)	Leakage Distance (mm)	Weight (Kg)	Dimensions (cm)
SJC-13	33-38	100	6,000	180	75	850	17	61X38 X14.5
		200	8,000	180	75	850	17	

**Lower Fuse Tube**

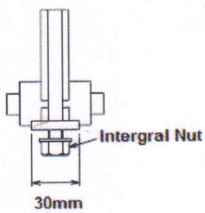

**Bottom Hanger**

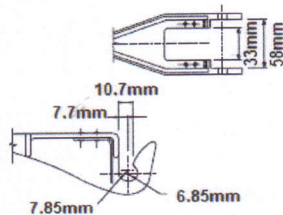

**SJC-18 POLYMER**

Type	Rated Voltage (KV)	Rated Current (A)	Breaking Current (A)	Impulse Voltage BIL (KV)	Power Frequency Withstand Voltage (KV)	Leakage Distance (mm)	Weight (Kg)	Dimensions (cm)
SJC-18	24-27	100	10,000	150	65	540	4.5	51X34 X11.5
		200	12,000	150	65	540	4.5	

**SJC-19 POLYMER**

Type	Rated Voltage (KV)	Rated Current (A)	Breaking Current (A)	Impulse Voltage BIL (KV)	Power Frequency Withstand Voltage (KV)	Leakage Distance (mm)	Weight (Kg)	Dimensions (cm)
SJC-19	24-27	100	10,000	170	70	720	5	61X34 X11.5
		200	12,000	170	70	720	5	

**SJC-34**

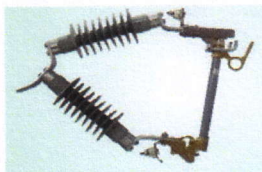

**SJC-34 POLYMER**

Type	Rated Voltage (KV)	Rated Current (A)	Breaking Current (A)	Impulse Voltage BIL (KV)	Power Frequency Withstand Voltage (KV)	Leakage Distance (mm)	Weight (Kg)	Dimensions (cm)
SJC-34	24-27	100	10,000	125	70	720	12	51X34 X11.5
		200	12,000	125	70	720	12	